



UNDERCOUNTER FREEZER

MODEL DUC48F
2-Door













TECHNICAL SPECIFICATIONS

Voltage/Frequency	115V/60Hz
Refrigerant	R290
Type of Defrost	Automatic
Interior Material	Stainless Steel
Exterior Material	Stainless Steel
Temperature Range °F	0 ~ -8°F
Compressor Power (HP)	1/2-
Nema Config.	NEMA5-15P



PRODUCT FEATURES

-  The compressor is mounted in the back and placed in the coolest possible area; this makes it easily accessible for servicing.
-  Digital temperature controls with LED display for precise adjustment and automatic defrosting system.
-  Temperatures in the cabinet range from 0 to -8 degrees Fahrenheit.
-  Higher Resistance to dust, high quality condenser.
-  R290 Natural Refrigerant promotes faster cool down and efficient energy consumption.
-  Self-closing doors at 60° with stay open feature.
-  Stainless steel interior & exterior, sealed interior floors, and rounded cabinet corners for easy cleaning.
-  High quality coated stainless adjustable shelves prevent peel and rust.
-  Lifetime warranty on hinges.
-  6" casters with lock for easy mobility.



HIGH QUALITY STAINLESS STEEL & ROBUST DESIGN

DETAILS & SPECIFICATIONS

UNDERCOUNTER DUC48F

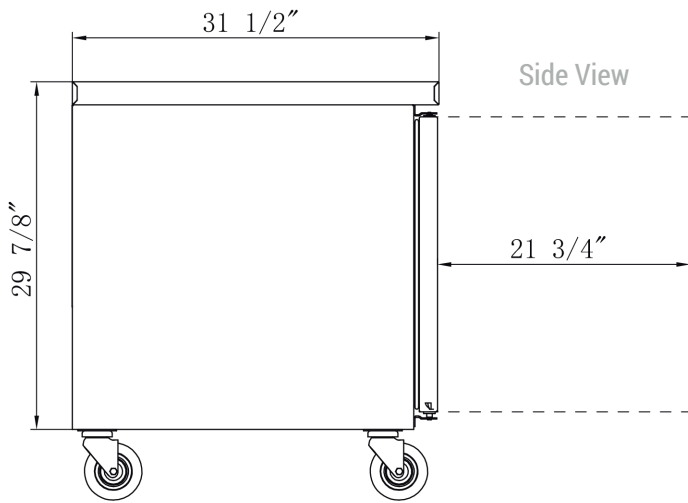
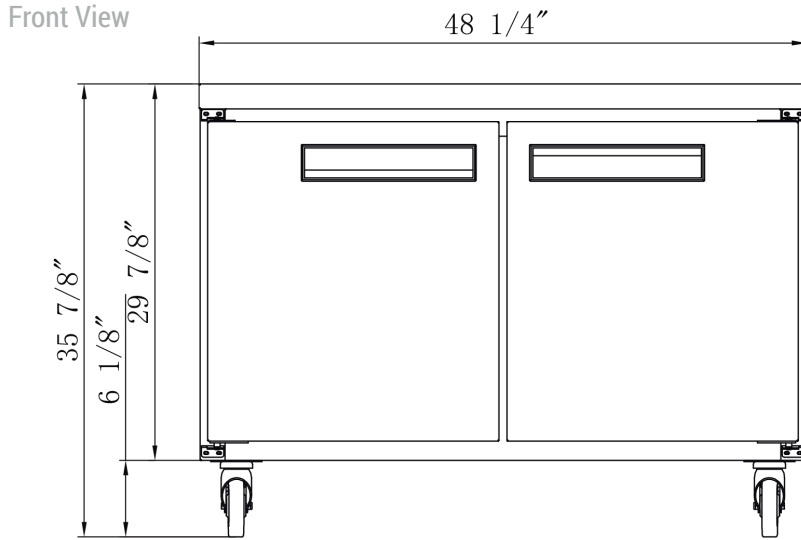

MODEL DUC48F

Rated Voltage	115V
Rated Frequency	60Hz
Total Input Power	660W
Total Current	8.0A
Total Capacity	12.21 cu ft
Climatic Category	4-5
Protection Type	I
Design Pressure High Side	300 PSIG
Design Pressure Low Side	150 PSIG
Insulation Blowing Gas	C-Pentane
Refrigerant	R290/3.70oz

MODEL	EXTERNAL DIMENSION WXDXH (INCHES)	PACKAGING DIMENSION WXDXH (INCHES)	PRODUCT NET WEIGHT	# OF SHELVES	40HQ CONTAINER CERT.
DUC48F	48 1/4 x 31 1/2 x 36	49 5/8 x 33 1/8 x 39 3/8	211 lbs	2	46

