



DUKERS

Quality Commercial Refrigeration











CHEST FREEZER

BD/BG-520



PRODUCT FEATURES

-  Fan assisted condenser & copper evaporator.
-  Temperatures in the cabinet range from -10 to 0 degrees Fahrenheit.
-  R290 Natural Refrigerant promotes faster cool down and efficient energy consumption.
-  White coated steel exterior & aluminum interior, defrost drain.
-  Epoxy coated white baskets.
-  3" casters.
-  Solid hinged lid.
-  Digital controller and LED temperature display.
-  Interior LED light.



TECHNICAL SPECIFICATIONS

Refrigerant	R290
Type of Defrost	Manual
Interior Finish	White
Interior Finish	Embossed aluminum
Temperature Range °F	-10 ~ 0 °F
Compressor Power (HP)	2/7
Nema Config.	NEMA5-20P



HIGH QUALITY STAINLESS STEEL & ROBUST DESIGN

DETAILS & SPECIFICATIONS

CHEST FREEZER BD/BG 520

Front View

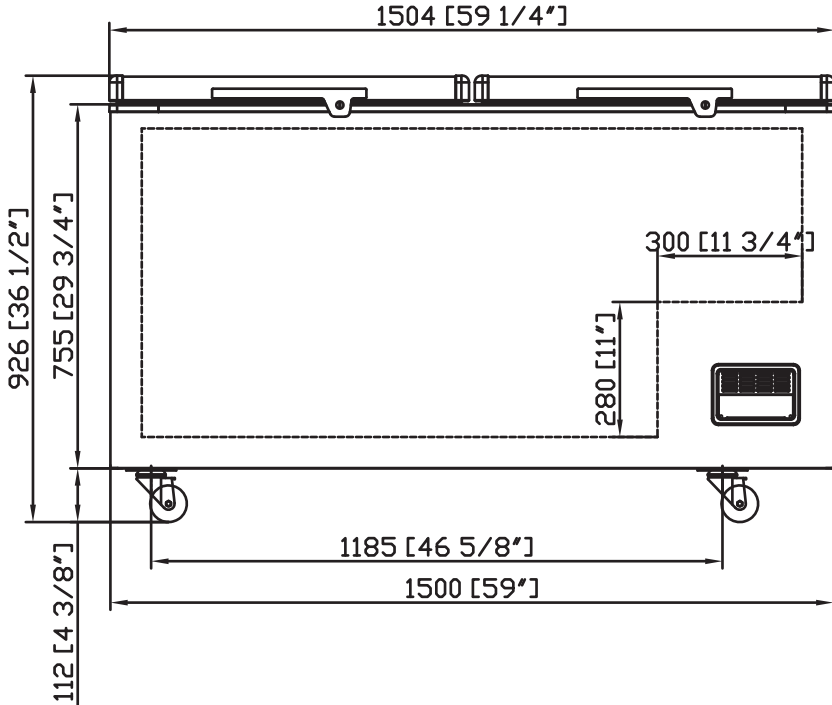

Side View

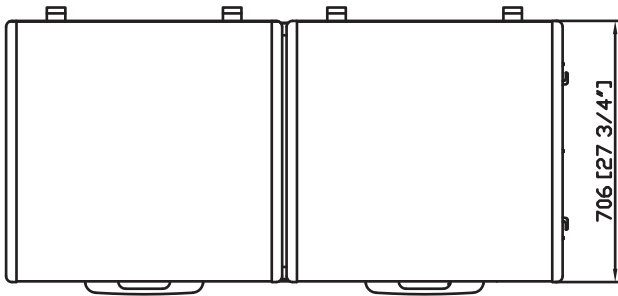
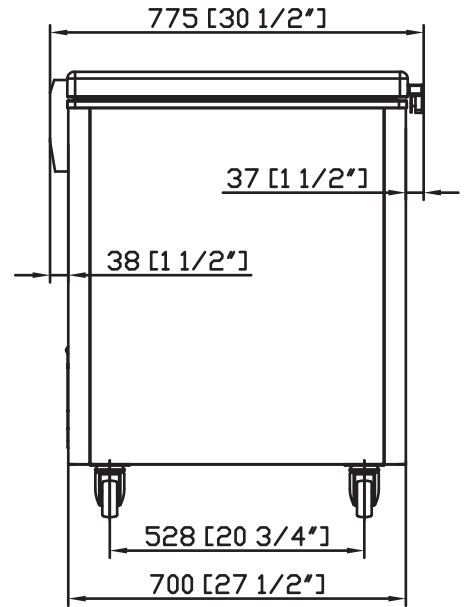

Top View

MODEL BD/BG 520

Number of baskets	2
Compressor Power (HP)	2/7
Refrigerant	R290
Volume	16.1 cu ft

MODEL	EXTERNAL DIMENSION WXDXH (INCHES)	PACKAGING DIMENSION WXDXH (INCHES)	PRODUCT NET WEIGHT	# OF BASKETS	40HQ CONTAINER CERT.
BD/BG 520	59 1/4 x 27 3/4 x 36 1/2	64 2/8 x 34 1/8 x 38	165.35 lbs	2	28

